

CAMO[®]

FASTENERS

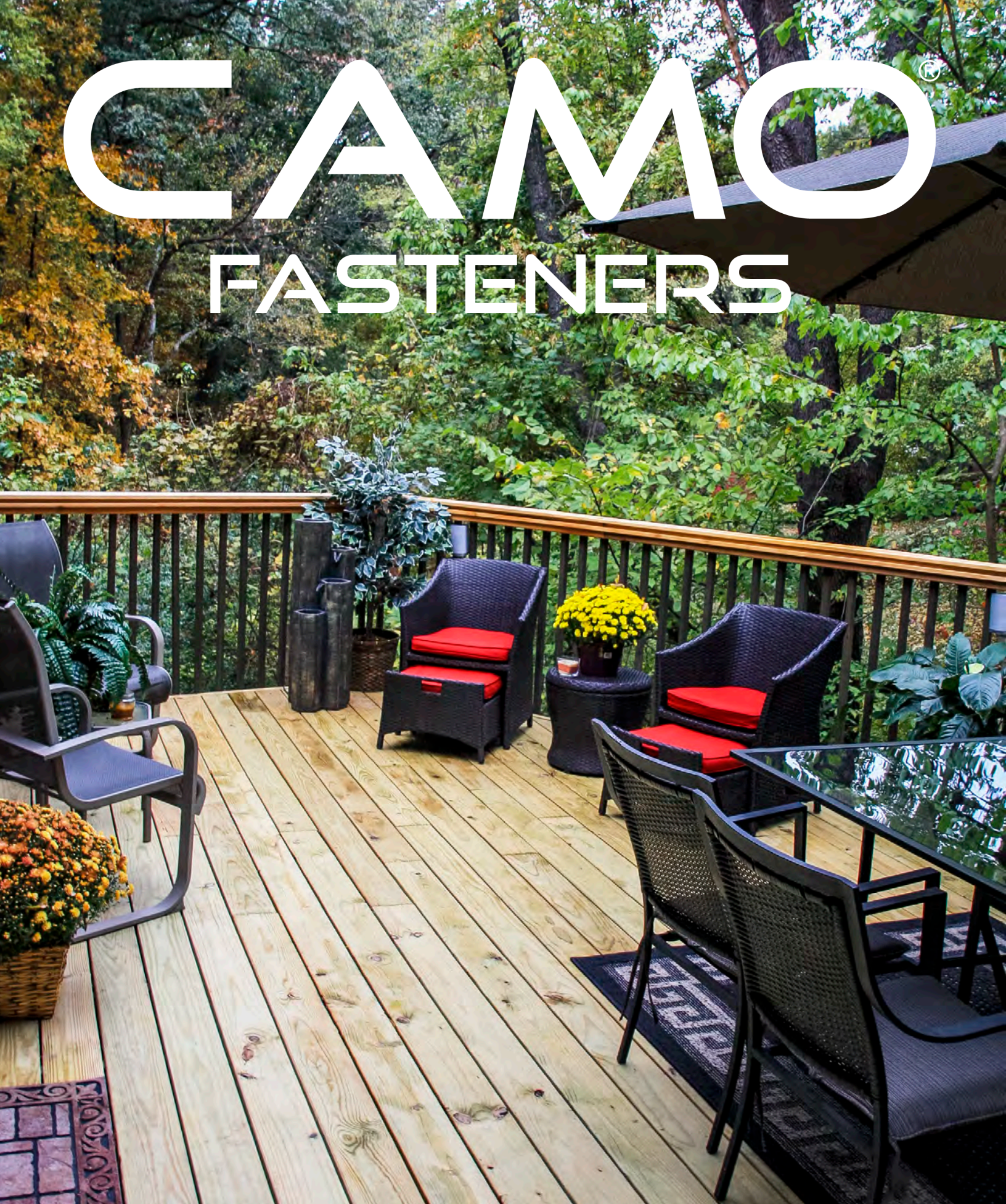

BRAND EXPERIENCE

Solutions Center	2
Packaging.....	4
Dress for Success	5
Merchandisers	6

WHAT'S NEW

What's New	8
------------------	---

EDGE DECK FASTENING SYSTEM

Guides.....	10
Screws	14
Driver and Pre-Drill Bits.....	17

FACE FASTENING

Exterior Screws.....	18
Premium Deck Screws	20
Premium Trim Screws.....	24
Premium Trim Color Cross-Reference Guide.....	28
Composite Screws	30
Composite Color Cross-Reference Guide.....	36

HIDDEN FASTENING

CAMO Universal Deck Clip.....	40
-------------------------------	----

STRUCTURAL SCREWS

Structural Screws	42
Structural Screw Test Data.....	46

NATIONAL NAIL

Our Brands.....	48
-----------------	----

SOLUTIONS CENTER



SOLUTIONS CENTER

Changing the FACE of Decking® is the assignment, so it's no surprise that CAMO is focused on innovative, high quality deck fastening solutions for the Pro and DIYer. From securing the substructure to fastening the deck boards, fascia and trim, CAMO offers a full line of premium fastening products and systems for deck and exterior projects, including game-changing, patented Edge Fastening technologies that create a Barefoot Approved™ fastener-free surface for wood, composite and PVC boards.

BRAND EXPERIENCE

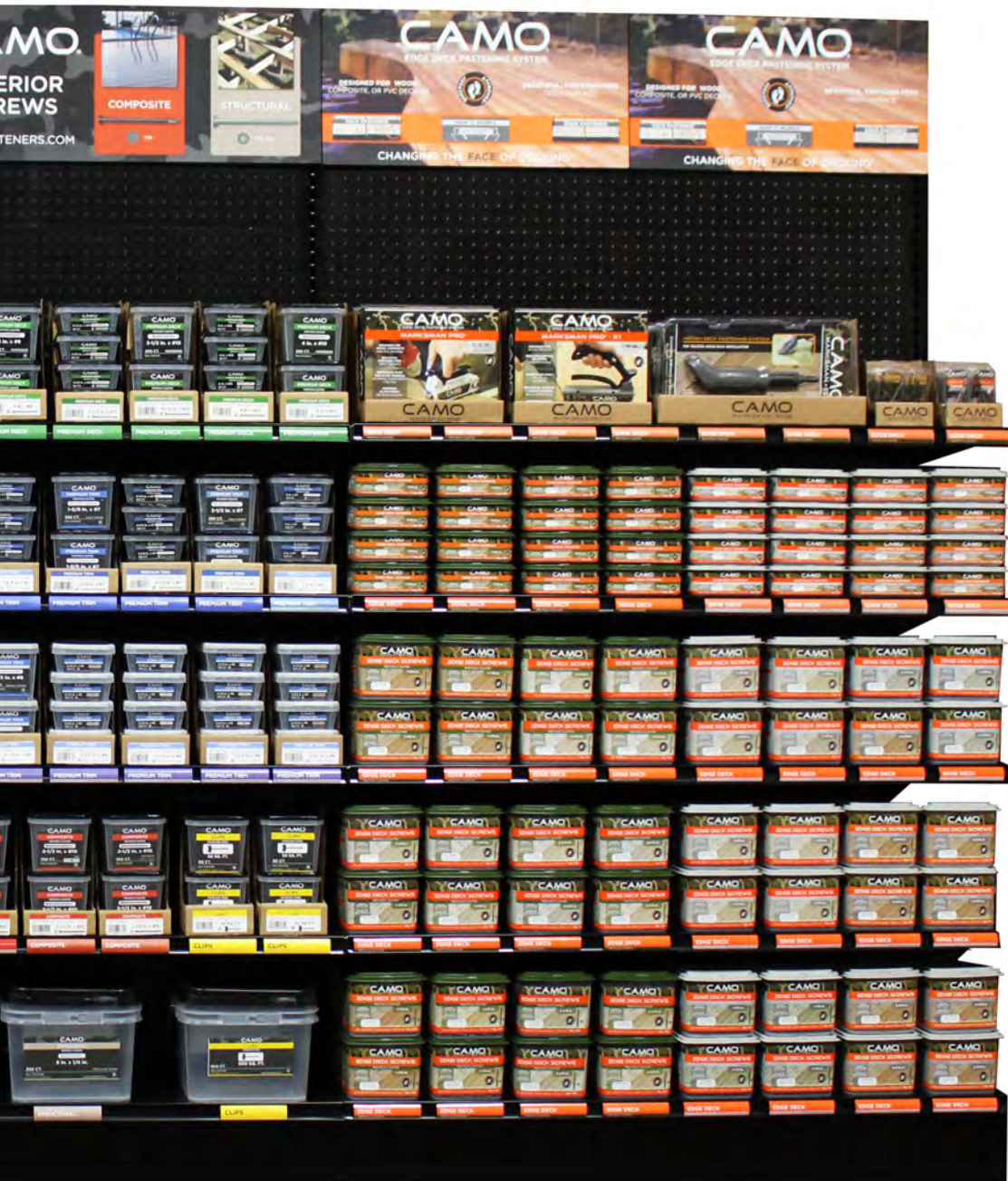

Innovation - It's about being a thought leader and bringing something new to the market. CAMO is building the Edge Fastening category with unique patented technologies for the Pro and DIYer.

Shopability - On-the-shelf and in-the-aisle Dress for Success merchandising and color-coding that improves way-finding, grows connect rates, and builds brand awareness.

Quality - From the moment you approach the CAMO shelf, you experience what Premium means: fasteners, guides and accessories engineered for confidence and dependability; star drive fasteners and power bits; and fasteners packaged in pails with informative labeling. And CAMO Quality is backed by warranties designed to give you and your customers peace of mind.

PACKAGING

SMART PACKAGING

CAMO® packaging reflects a brand personality that connects the builder with the product. Small master counts reduce inventory investment and increase turns. And with fastener count and square foot coverage (where applicable) on the label, and a drill bit in each package, consumers know exactly what they're buying to get the job done.

Package Label

CAMO
EDGE DECK FASTENING SYSTEM

EDGE DECK SCREWS

PROTECH COATED

BEAUTIFUL FASTENER-FREE DECK SURFACE

DESIGNED FOR WOOD, COMPOSITE AND PVC DECKING

1-7/8 in.

HOW IT WORKS

For use with CAMO guides only

BAFF FOOT APPROVED

SKU #0345119 | Covers Approx. 500 sq. ft. | Qty: 1750

CAMO

PREMIUM DECK

PROTECH COATED

1-5/8 in. x #8

350 CT. Green Buglehead

SKU 0341104

EXTERIOR SCREWS

BIT INCLUDED



DRESS FOR SUCCESS

From the parking lot to the aisle, our Dress for Success merchandising assists your customers with finding exactly what they are looking for. From banner signs and door clings that draw customers into your store, to bold header boards, informative aisle violators, color-coded shelf talkers, and counter mats for your contractor desk, these visual aids build brand awareness and make product selection easy.

Headerboard



Yard Banner

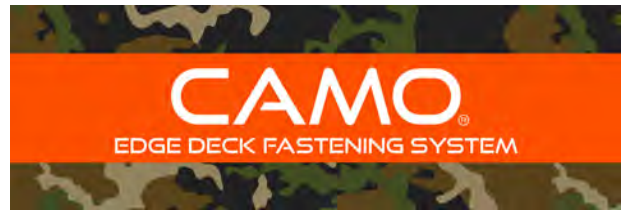

Shelf Talkers

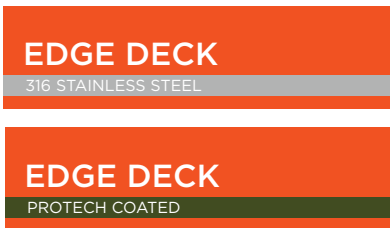

Door Cling



Aisle Violator



Counter Mat



Description	SKU#
Edge Counter Mat	MK1015
Door Cling	MK1018
Aisle Violator	MK1021
Header Board	0345993
Shelf Talker - ProTech	0001155BH
Shelf Talker - Stainless	0001155BI
Yard Banner	0345994

CAMO® Edge Fastening

Our merchandisers are designed to attract, engage and motivate customers to purchase our products. Using color-coding and detailed graphics with call-outs, our header boards and side panels help reinforce the brand and educate customers to make informed buying decisions.

CAMO Edge Fastening System



0345952

CAMO/AZEK



0345952-AZK

CAMO Countertop



0345967 (shown), 0345969, 0345968

SKU#	MERCHANDISER	DESCRIPTION
0345952	Marksman Edge®	Beautifully designed Point-of-Purchase wire rack merchandiser for high profile placement of the CAMO EDGE FASTENING SYSTEM.
0345952-AZK	CAMO®/AZEK®	Point-of-Purchase wire rack merchandiser for high profile placement of the co-branded CAMO for AZEK Edge Fastening System.
0345967	Countertop Merchandiser	Contains 3 Marksman Pro® Guides and 6 350ct. CAMO Edge Screws.
0345969	Countertop Merchandiser	Contains 3 Marksman Pro-X1® Guides and 6 350ct. CAMO Edge Screws.
0345968	Countertop Merchandiser	Contains 3 Marksman Pro-NB® Guides and 6 350ct. CAMO Edge Screws.

CAMO® EXTERIOR

Exterior Screws



0001190

MERCHANDISER HEADER OPTIONS

Premium Deck



0001193

Composite



0001199

Stainless



0001198

Structural

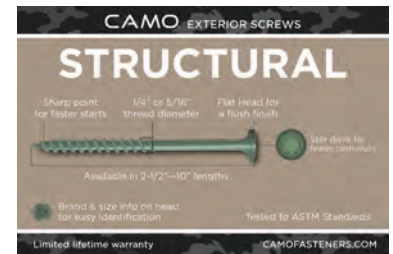

0001195

SKU#	MERCHANDISER	DESCRIPTION
0001190	Exterior Screws	The mixed CAMO Exterior Screw merchandiser offers a variety of ProTech coated bugle head deck, trim head and color matched composite premium screws for a variety of outdoor projects.
0001193	Premium Deck Screws	The CAMO Premium Deck merchandiser offers dedicated high profile space for fast selling ProTech bugle head premium deck screws. A great solution for any outdoor project.
0001199	Composite Deck Screws	The CAMO Composite Screw merchandiser provides a wide variety of colors to match most leading composite and PVC deck boards.
0001198	Stainless Steel Screws	For areas where extreme corrosion resistance is a necessity such as in coastal waterways, the CAMO Stainless Steel merchandiser offers dedicated high profile space to display.
0001195	Structural Screws	The CAMO Structural Screw merchandiser offers dedicated space for a variety of structural screw solutions including Ledger, Multi-Purpose 1/4" and heavy duty 5/16" screws available in lengths from 2 1/2" - 10"

WHAT'S NEW



UNMATCHED PROTECTION

We're confident in CAMO Edge Fastening. So confident, we've put it in writing. Our CAMO® Warranty has always guaranteed against defective product, rust and corrosion. What sets our Warranty apart is the protection it provides for the deck boards. In the event CAMO Edge Deck Screws cause the board product to fail - we will replace the damaged deck board product at no charge. That's performance and protection you can count on. For complete warranty details, go to www.camofasteners.com.

WE'VE GOT STAINLESS

When you need a stainless fastener, CAMO has you covered with a full selection of stainless steel Premium Deck, Premium Trim, and Composite screws in a variety of colors that match those of leading deck board manufacturers. You'll find them merchandised on the shelf with CAMO Exterior or in the aisle on a dedicated merchandiser.
(Page 7)

BRAND EXPERIENCE

EDGE FASTENING FOR PVC

The CAMO Marksman Pro®-X2 and CAMO PVC Hidden Fasteners are designed specifically for installing any PVC deck board product, including AZEK. The Pro-X2 guides the stainless steel deck screws into the edge of the deck board and automatically creates a 1/8”(3mm) gap, the recommended minimum spacing for installing PVC boards. The screws have the same reduced trimhead, star drive and shank design as CAMO Edge Deck Screws, but have a sharp point for faster starts in PVC.

(Page 11)



EXTREME MAKEOVER

CAMO Exterior has a great new look! Check out the new packaging in plastic pails - they fit the same shelf space as the original boxes. New product categories include an expanded Structural Screw line, along with ProTech coated and 316 Stainless Steel Premium Deck, Premium Trim, and Composite Screws in colors to match most wood, composite and capped composite boards. New color-coded labels and point-of-purchase materials help you easily locate the right fasteners on the shelf, and five dedicated merchandisers make cross-merchandising a breeze.

(Beginning Page 18)



UNIVERSAL HIDDEN DECK CLIP

Installing grooved deck boards? CAMO Clips work with most grooved boards including Trex®, TimberTech®, AZEK®, Fiberon and many more. The stainless steel clip and fastener are pre-assembled for easy installation, and creates an automatic 1/4”(6mm) gap. 90° fastener entry secures the clip to the joist, and the serrated clip edge helps prevent board creep. You'll find them merchandised on the shelf with CAMO Exterior or in the aisle on a dedicated merchandiser.

(Page 40)





WHAT IS EDGE FASTENING?

Designed to create a fastener-free deck surface, CAMO Marksman guides are used to install a multitude of different deck products including:

- Wood deck board products including softwoods such as pressure treated lumber, cedar, redwood and other similar products and hardwoods including Ipe, Kebony®, Tigerwood, Ironwood, Cumaru and other similar products.
- Wood alternative deck board products (solid and grooved) such as composite, capped composite, and PVC decking products including those manufactured by Trex®, Fiberon, AERT, CPG Building Products (Timbertech® and AZEK® brands), TAMKO®, Wolf® and other similar products.

How It Works

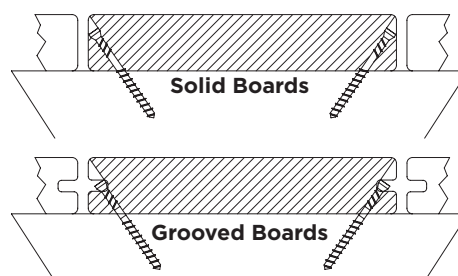

CAMO® Marksman Pro® guides are heavy-duty, contractor grade tools. Their clamping action grips the deck board and perfectly lines up the dual screw guide holes ready to drive CAMO® screws into each 'Edge' of the board - leaving a beautiful, fastener free, deck surface. Choose your guide based on your deck board size and desired gap spacing.



MARKSMAN PRO®

- For use with treated, hardwood, cedar, composite and PVC deck boards
- Fits most 5-1/4" (133mm) to 5-3/4" (146mm) deck board
- Automatic 3/16" (5mm) spacing



MARKSMAN PRO® - X1

- For use with treated and other softwood lumber
- Fits most 5-1/4" (133mm) to 5-3/4" (146mm) deck board
- Automatic 1/16" (3mm) spacing



MARKSMAN PRO® - X2

- For use with composite and PVC deckboards
- Fits most 5-1/4" (133mm) to 5-3/4" (146mm) deck board
- Automatic 1/8" (3mm) spacing



MARKSMAN PRO® - NB

- For use with treated, hardwood, cedar, composite and PVC deck boards. For narrow deck boards measuring 3-1/4" (83mm) to 5" (127mm)
- Automatic 3/16" (5mm) spacing



MARKSMAN EDGE™

- For use with treated and other softwood lumber
- No installed gap between boards
- Attaches to any drill
- Heavy-duty, contractor grade tool
- For additional gap options, can be used with secondary spacers

SKU#	DESCRIPTION	QTY	CT./MASTER
0345001	Marksman Pro	1	6
0345002	Marksman Pro - X1	1	6
0345003-AZK	Marksman Pro - X2	1	6
0345015	Marksman Pro - NB	1	6
0345020	Marksman Edge	1	6

EDGE PRO | COLLATED FASTENING



Installing a fastener-free deck surface is fast and easy with the CAMO Collated Edge Pro Fastening System.

Designed for no-gap installation of treated wood decking, the CAMO Edge Pro can also be used with a wide variety of wood, composite, and PVC deck boards and secondary spacers.

The CAMO Edge Pro and CAMO Collated Edge Deck Screws attach boards directly to the joist. The secure side-angle entry reduces splitting, cracking and fastener pops inherent with face-fastened deck boards.

No matter which deck material you choose, the Edge Pro provides a beautiful deck surface that will be enjoyed for years to come.

EDGE PRO



- High-speed, collated edge deck fastening system
- For use with treated and other softwood lumber, but can be used on most types of decking
- Heavy-duty, contractor-grade tool
- No installed gap between boards
- For additional gap options, can be used with secondary spacers

Includes:

- Milwaukee Drill
- Edge Pro Attachment
- 2 Driver Bits
- Carrying Case

SKU#	DESCRIPTION	QTY	CT./MASTER
0345050	Edge Pro	1	1

COLLATED EDGE DECK SCREWS



- 50 CAMO Collated Edge Deck Screws per strip
- 2-3/8" (60mm)
- For use with the Edge Pro only

SKU#	SIZE	QTY	ALLOY
0345343	2-3/8" (60mm) x #7	1000	ProTech
0345443S	2-3/8" (60mm) x #7	1000	316 SS

EDGE PRO DRIVER BIT

SKU#	DESCRIPTION	QTY	CT./MASTER
0345079	Edge Pro Driver	2/pk	4

- Replacement driver bit for the CAMO Edge Pro
- For use with the CAMO Collated Edge Pro Fastening System only

EDGE DECK SCREWS



CAMO Edge Deck Screws are an innovative, easy-to-install alternative to face fastening, clips and other hidden fasteners. Great for wood decks, CAMO Edge Deck Screws deliver a high-end look at an affordable price. They work beautifully in solid and grooved composite or PVC materials; and with a Limited Warranty, CAMO stands the test of time.

WHAT MAKES EDGE FASTENING INNOVATIVE?

Versatile - Secures solid or grooved treated lumber, hardwood, cedar, composite or PVC deck boards.

Affordable - Priced like a deck screw, CAMO Edge Deck Screws cost less than \$.30/sq.ft. when using the 1-7/8" (48mm) ProTech Coated carbon steel screws.

Easy - No pre-drilling is required* and Marksman guides provide automatic spacing or no gap installation. It's as easy as SET - LOAD - DRIVE.

Secure - Attaches deck boards directly to the joist reducing board movement. CAMO Edge Deck Screws have been independently tested and exceed ICC-ES Acceptance Criteria for Deck Board Span Ratings and Guardrail Systems (Guards and Handrails) (AC174) (Section 4.1.4) in all wood, composite and PVC boards tested.

Removable - Screws back out easily if board replacement is necessary - just put the drill in reverse.

ACQ Compatible - CAMO's proprietary ProTech coating provides three protective layers that pass a 1500 hour salt spray test in accordance with ASTM B117 and guards against corrosion when used with chemically treated wood. 316 Stainless Steel offers ultimate corrosion resistance and is recommended for coastal environments.

*When using Stainless Steel CAMO Edge Deck Screws with hardwood decking, pre-drilling is required.

EDGE DECK SCREWS

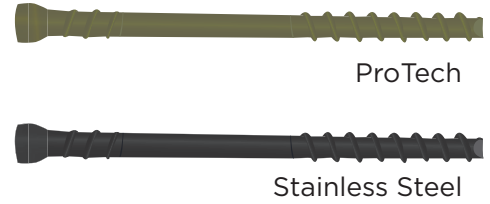
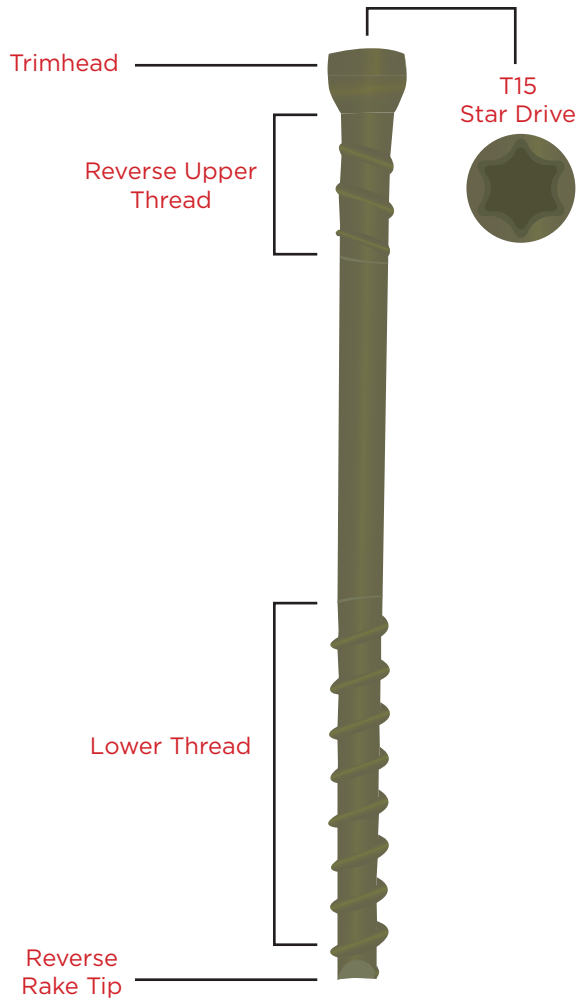

Available in 1-7/8" (48mm) and 2-3/8" (60mm) ProTech coated carbon steel and 304 or 316 Stainless Steel

- Reduced Trimhead design provides a less visible point of entry
- Star Drive offers more points of contact for better performance and reduces bit slippage and wear
- Reverse Upper Thread pulls the board tight to the joist and provides a clean, finished entry
- Aggressive Lower Thread pattern provides superior holding power
- Reverse Rake Tip removes deck material as it bores, allowing the screw to penetrate the board without splitting

DECK BOARD MATERIAL	RECOMMENDED CAMO EDGE DECK FASTENER
Pressure Treated Lumber	Stainless Steel or ProTech Coated
Composite or Capped Composite	Stainless Steel or ProTech Coated
PVC	Stainless Steel or ProTech Coated
Cedar	Stainless Steel
Redwood	Stainless Steel
Hardwood or Imported Hardwood	Stainless Steel (with pre-drilling)



EDGE DECK SCREWS

ProTech COATED

SKU#	SIZE	QTY	DRIVER BIT	CT./MASTER
0345120	1-7/8" (48mm) x #7	100	--	12
0345128		350	1 - T15	12
0345124		700	2 - T15	4
0345119		1750	2 - T15	4
0345140	2-3/8" (60mm) x #7	100	--	12
0345148		350	1 - T15	12
0345144		700	2 - T15	4
0345139		1750	2 - T15	4

304 STAINLESS STEEL (NEW ITEM - AVAILABLE SUMMER 2017)

SKU#	SIZE	QTY	DRIVER BIT	CT./MASTER
0345748	2-3/8" (60mm) x #7	350	1 - T15	12
0345744		700	2 - T15	4
0345739		1750	2 - T15	1

316 STAINLESS STEEL

SKU#	SIZE	QTY	DRIVER BIT	CT./MASTER
0345220S	1-7/8" (48mm) x #7	100	--	12
0345228S		350	1 - T15	12
0345224S		700	2 - T15	4
0345219S		1750	2 - T15	1
0345240S	2-3/8" (60mm) x #7	100	--	12
0345248S		350	1 - T15	12
0345244S		700	2 - T15	4
0345239S		1750	2 - T15	1

AZEK® CO-BRANDED STAINLESS STEEL (SHARP POINT FOR PVC ONLY)

SKU#	SIZE	QTY	DRIVER BIT	CT./MASTER
0345539S	2-3/8" (60mm) x #7	350	1 - T15	12
0345544S		700	2 - T15	4
0345548S		1750	2 - T15	1

1-7/8" (48mm) - FOR USE WITH 3/4" (19mm) - 1" (25mm) DECK BOARDS

2-3/8" (60mm) - FOR USE WITH 1" (25mm) - 1-1/2" (38mm) DECK BOARDS

DECKPACS

SKU#	SIZE	QTY	DRIVER BIT	CT./MASTER
0345100*	1-7/8" (48mm) x #7	700	2 - T15	4
0345107**		1050	2 - T15	4
0345110***	2-3/8" (60mm) x #7	700	2 - T15	4

*Deckpac contains the Marksman Edge, 700 ProTech coated Edge fasteners, 2 T15 driver bits

**Deckpac contains the Marksman Edge, 1050 ProTech coated Edge fasteners, 2 T15 driver bits

***Deckpac contains the CAMO Marksman Pro, 700 ProTech coated Edge fasteners, 2 T15 driver bits

DRIVER AND PRE-DRILL BITS

CAMO Driver Bits are engineered specifically for use with CAMO Edge Deck Fastening System. The built-in shoulder sets automatic depth of drive for maximum holding power, and prevents over-driving the screw.

SKU#	DESCRIPTION	QTY	CT./MASTER
0345099	Driver Bit	2/pk	10
0345089	Driver Bit for Grooved Board	2/pk	10
0345035	Pre-Drill Bit	2/pk	10

DRIVER BITS AND PRE-DRILL BITS



EXTERIOR SCREWS



CAMO Exterior screws provide a great fastening solution for whatever your exterior project demands. Built for premium protection and performance whether ProTech or stainless steel is selected for your project, CAMO Fasteners are compatible and warranted with today's complex variety of treated lumber and synthetic decking materials. CAMO has you covered.

CAMO ProTech coating provides a triple layer of protection with zinc dichromate covered with two layers of the CAMO proprietary ProTech polymer. ProTech coated CAMO Exterior Fasteners pass a minimum of 1500 hour salt spray test in accordance with ASTM B117.

CAMO 305 or 316 Stainless Steel fasteners offer superior corrosion resistance when conditions demand. 316 stainless is recommended for marine and coastal environments.

Our high-quality CAMO Exterior Screws include 4 categories:

CAMO Premium Deck - Multi-purpose bugle head screws for decking and other exterior projects

CAMO Premium Trim - Trimhead screws for finishing applications

CAMO Composite - Color-coded to match the color of your deck board

CAMO Structural - Strength and durability for the posts, sub frame and joists

FACE FASTENING



305 or 316 Stainless Steel: Offer superior corrosion resistance. 316 Stainless is recommended for marine and coastal environments.

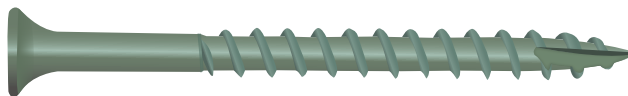

ProTech coated carbon steel: Two ProTech coatings over a layer of zinc dichromate passes a 1500 hour salt spray test in accordance with ASTM B117.

POWER BITS

CAMO Power Bits are engineered specifically for use with CAMO Exterior Screws. The built-in shoulder sets automatic depth of drive for maximum holding power, and prevents over-driving the screw.



SKU#	DESCRIPTION	QTY	CT./MASTER
0333900	T15 Star Drive	3	10
0333910	T20 Star Drive	3	10
0333920	T25 Star Drive	3	10
0333990	T30 Star Drive	3	10
0333930	T40 Star Drive	3	10



PREMIUM DECK SCREWS



CAMO premium buglehead deck screws blend in with wood surfaces and secure your project for a lifetime.

WHAT MAKES THESE DECK SCREWS PREMIUM?

Screw Design - Head style and 2/3 thread design combine to draw the board tight without cutting into the board, leaving a flush finish.

Star Drive - Provides more points of contact to reduce cam-out and eliminate excessive wear on the screw head and bit.

Type 17 Slash Point - Starts fast and makes it easier to drive the screw.

ACQ Compatible - CAMO's proprietary ProTech coating provides three protective layers that pass a 1500 hour salt spray test in accordance with ASTM B117 and guards against corrosion when used with chemically treated wood. Also available in 305 or 316 Stainless Steel.

Limited Warranty - CAMO guarantees against rust and corrosion for the life of the project.

PREMIUM DECK SCREWS

Buglehead Screws

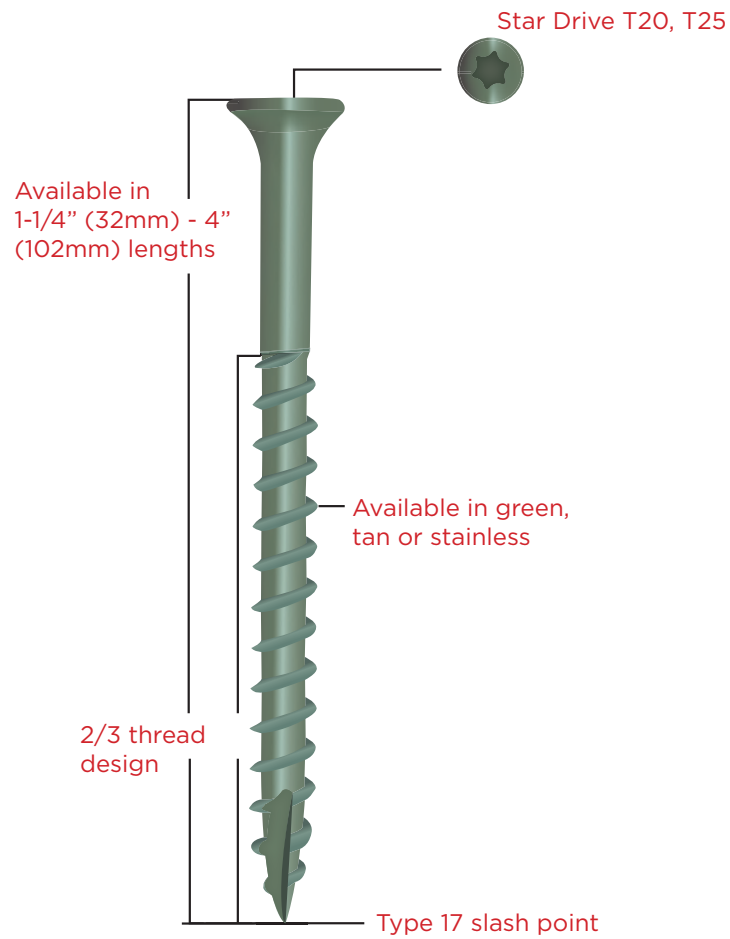

 CAMO Power Bit included in each package



PREMIUM DECK SCREWS

PROTECH COATED

GREEN SKU#	TAN SKU#	SIZE	QTY	CT./MASTER
0341070	0356070	1-1/4" (32mm) x #7	100	12
0341074	0356074		350	4
0341100	0356100	1-5/8" (41mm) x #8	100	12
0341104	0356104		350	4
0341109	0356109		1750	1
0341130	0356130	2" (51mm) x #8	100	12
0341134	0356134		350	4
0341139	0356139		1750	1
0341150	0356150	2-1/2" (64mm) x #9	100	12
0341154	0356154		350	4
0341159	0356159		1750	1
0341170	0356170	3" (76mm) x #9	100	12
0341174	0356174		350	4
0341179	0356179		1750	1
0341190	0356190	3-1/2" (89mm) x #10	50	12
0341194	0356194		250	4
0341199	0356199		1350	1
0341200	0356200	4" (102mm) x #10	50	12
0341204	0356204		250	4
0341209	0356209		1350	1

305 STAINLESS STEEL

SKU#	SIZE	QTY	CT./MASTER
0348150	2-1/2" (64mm) x #10	100	12
0348154		350	4
0348159		1750	1
0348170	3" (76mm) x #10	100	12
0348174		350	4
0348179		1750	1

316 STAINLESS STEEL

SKU#	SIZE	QTY	CT./MASTER
0348100S	1-5/8" (41mm) x #9	100	12
0348104S		350	4
0348130S	2" (51mm) x #9	100	12
0348134S		350	4
0348139S		1750	1
0348150S	2-1/2" (64mm) x #10	100	12
0348154S		350	4
0348159S		1750	1
0348170S	3" (76mm) x #10	100	12
0348174S		350	4
0348179S		1750	1
0348190S	3-1/2" (89mm) x #10	50	12
0348194S		250	4
0348199S		1350	1



PREMIUM TRIM SCREWS



For exterior trim and a variety of other exterior projects, CAMO® Premium Trim Screws blend in with your material and secure your project for a lifetime.

WHAT MAKES THESE TRIM SCREWS PREMIUM?

Screw Design - Trimhead style and 2/3 thread design combine to draw the board tight, leaving less screw visibility for your exterior finish projects.

ACQ Compatible - CAMO's proprietary ProTech coating provides three protective layers that pass a 1500 hour salt spray test in accordance with ASTM B117 and guards against corrosion when used with chemically treated wood. Also available in 305 and 316 stainless steel.

Star Drive - More points of contact to reduce cam-outs and deliver higher torque.

Type 17 Slash Point - Starts fast and makes it easier to drive the screw.

Limited Warranty - CAMO® guarantees against rust and corrosion for the life of the project.

PREMIUM TRIM SCREWS

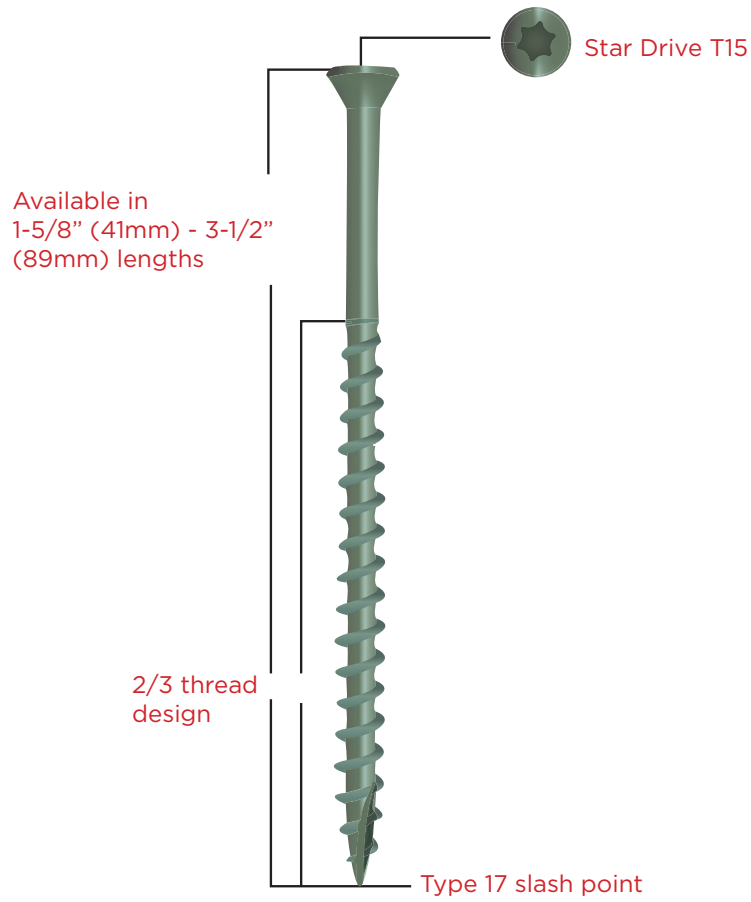

 CAMO Power Bit included in each package



PREMIUM TRIM SCREWS

PROTECH COATED

SKU#	SIZE	QTY	CT./MASTER
0346100	1-5/8" (41mm) x #7	100	12
0346104		350	4
0346130	2" (51mm) x #7	100	12
0346134		350	4
0346150	2-1/2" (64mm) x #7	100	12
0346154		350	4
0346170	3" (76mm) x #7	100	12
0346174		350	4
0346190	3-1/2" (89mm) x #8	100	12
0346194		350	4

316 STAINLESS STEEL

SKU#	SIZE	QTY	CT./MASTER
0350100S	1-5/8" (41mm) x #8	100	12
0350104S		350	4
0350130S	2" (51mm) x #8	100	12
0350134S		350	4
0350150S	2-1/2" (64mm) x #8	100	12
0350154S		350	4
0350170S	3" (76mm) x #8	100	12
0350174S		350	4
0350190S	3-1/2" (89mm) x #8	100	12
0350194S		350	4

316 STAINLESS STEEL

SKU#	SIZE	QTY	CT./MASTER	COLOR
0353100S	1-5/8" (41mm) x #8	100	12	White
0353104S		350	4	
0353109S		1750	1	
0353150S	2-1/2" (64mm) x #8	100	12	
0353154S		350	4	
0353159S		1750	1	



316 STAINLESS STEEL PAINTED

SKU#	SIZE	QTY	CT./MASTER	COLOR
0353000BS	1-5/8" (41mm) x #8	100	12	Brown
0353004BS		350	4	
0353009BS		1750	1	
0353050BS	2-1/2" (64mm) x #8	100	12	
0353054BS		350	4	
0353059BS		1750	1	
Separator				
0353000TS	1-5/8" (41mm) x #8	100	12	Tan
0353004TS		350	4	
0353009TS		1750	1	
0353050TS	2-1/2" (64mm) x #8	100	12	
0353054TS		350	4	
0353059TS		1750	1	
Separator				
0353000CS	1-5/8" (41mm) x #8	100	12	Cedar
0353004CS		350	4	
0353009CS		1750	1	
0353050CS	2-1/2" (64mm) x #8	100	12	
0353054CS		350	4	
0353059CS		1750	1	
Separator				
0353000ES	1-5/8" (41mm) x #8	100	12	Grey
0353004ES		350	4	
0353009ES		1750	1	
0353050ES	2-1/2" (64mm) x #8	100	12	
0353054ES		350	4	
0353059ES		1750	1	
Separator				
0353000RS	1-5/8" (41mm) x #8	100	12	Redwood
0353004RS		350	4	
0353009RS		1750	1	
0353050RS	2-1/2" (64mm) x #8	100	12	
0353054RS		350	4	
0353059RS		1750	1	



316 STAINLESS STEEL PAINTED

SKU#	SIZE	QTY	CT./MASTER	COLOR
0353000WS	1-5/8" (41mm) x #8	100	12	Winchester
0353004WS		350	4	
0353009WS		1750	1	
0353050WS	2-1/2" (64mm) x #8	100	12	
0353054WS		350	4	
0353059WS		1750	1	
<hr/>				
0353000NS	1-5/8" (41mm) x #8	100	12	Stone Grey
0353004NS		350	4	
0353009NS		1750	1	
0353050NS	2-1/2" (64mm) x #8	100	12	
0353054NS		350	4	
0353059NS		1750	1	
<hr/>				
0353000SS	1-5/8" (41mm) x #8	100	12	Sand
0353004SS		350	4	
0353009SS		1750	1	
0353050SS	2-1/2" (64mm) x #8	100	12	
0353054SS		350	4	
0353059SS		1750	1	
<hr/>				
0353000MS	1-5/8" (41mm) x #8	100	12	Mocha
0353004MS		350	4	
0353009MS		1750	1	
0353050MS	2-1/2" (64mm) x #8	100	12	
0353054MS		350	4	
0353059MS		1750	1	
<hr/>				
0353000DS	1-5/8" (41mm) x #8	100	12	Dark Brown
0353004DS		350	4	
0353009DS		1750	1	
0353050DS	2-1/2" (64mm) x #8	100	12	
0353054DS		350	4	
0353059DS		1750	1	



FACE FASTENING



COMPOSITE DECK SCREWS



For your next wood alternative deck project, CAMO® HAS YOU COVERED. These Composite Screws deliver unsurpassed performance and a beautiful flush finish in composite and PVC deck boards, including the latest capped composite materials.

WHAT MAKES THESE COMPOSITE SCREWS PERFORM?

Head Design - The leading edge of the head is designed to cut cleanly through the board surface to provide a smooth finish and small reveal. A T20 star drive offers more points of contact to reduce cam-out and eliminate excessive wear on the screw head and bit.

Screw Design - The unique trilobular shank reduces material displacement and allows higher torque. The sharp thread profile easily drives through the board, while the reverse thread design at the top captures displaced material and increases pull down power.

Type 99 Double Slash Point - Augers material for a fast start and easy penetration.

Color-Matched - To complement most leading manufacturer's composite, capped composite and PVC deck boards.

ACQ Compatible - CAMO's proprietary ProTech coating provides three protective layers that pass a 1500 hour salt spray test in accordance with ASTM B117 and guards against corrosion when used with chemically treated wood. Also available in 305 or 316 Stainless Steel.

Limited Warranty - CAMO guarantees against rust and corrosion for the life of the project.

COMPOSITE DECK SCREWS

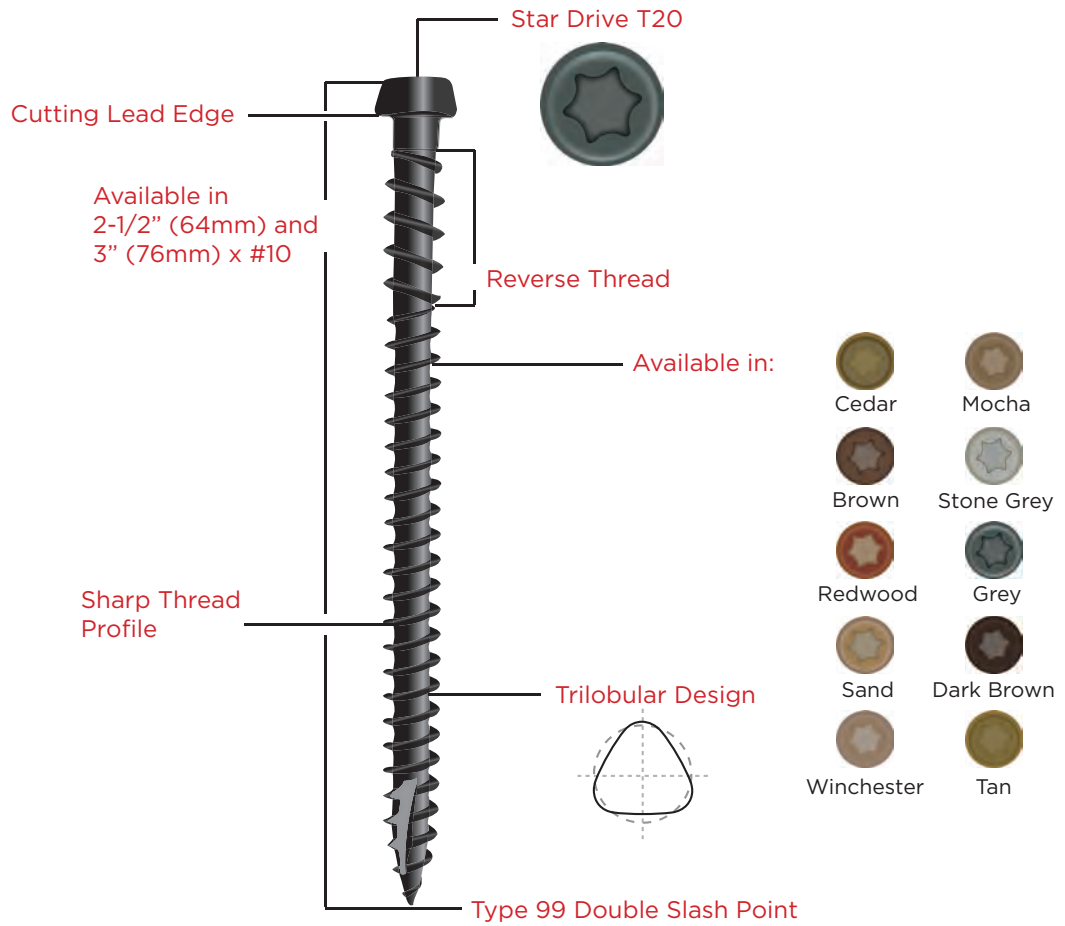







 CAMO Power Bit included in each package





COMPOSITE DECK SCREWS

PROTECH COATED

SKU#	SIZE	QTY	CT./MASTER	COLOR	
0349250	2-1/2" (64mm) x #10	100	12	Brown	
0349254		350	4		
0349259		1750	1		
0349274	3" (76mm) x #10	350	4		
0349279		1750	1		
 					
0349350	2-1/2" (64mm) x #10	100	12	Cedar	
0349354		350	4		
0349359		1750	1		
0349374	3" (76mm) x #10	350	4		
0349379		1750	1		
 					
0349050	2-1/2" (64mm) x #10	100	12	Dark Brown	
0349054		350	4		
0349059		1750	1		
0349074	3" (76mm) x #10	350	4		
0349079		1750	1		
 					
0349450	2-1/2" (64mm) x #10	100	12	Grey	
0349454		350	4		
0349459		1750	1		
0349474	3" (76mm) x #10	350	4		
0349479		1750	1		
 					
0349650	2-1/2" (64mm) x #10	100	12	Mocha	
0349654		350	4		
0349659		1750	1		
0349674	3" (76mm) x #10	350	4		
0349679		1750	1		
 					
0349550	2-1/2" (64mm) x #10	100	12	Redwood	
0349554		350	4		
0349559		1750	1		
0349574	3" (76mm) x #10	350	4		
0349579		1750	1		

PROTECH COATED

SKU#	SIZE	QTY	CT./MASTER	COLOR	
0349750	2-1/2" (64mm) x #10	100	12	Sand	
0349754		350	4		
0349759		1750	1		
0349774	3" (76mm) x #10	350	4		
0349779		1750	1		
0349950	2-1/2" (64mm) x #10	100	12	Stone Grey	
0349954		350	4		
0349959		1750	1		
0349974	3" (76mm) x #10	350	4		
0349979		1750	1		
0349150	2-1/2" (64mm) x #10	100	12	Tan	
0349154		350	4		
0349159		1750	1		
0349174	3" (76mm) x #10	350	4		
0349179		1750	1		
0349850	2-1/2" (64mm) x #10	100	12	Winchester	
0349854		350	4		
0349859		1750	1		
0349874	3" (76mm) x #10	350	4		
0349879		1750	1		



COMPOSITE DECK SCREWS

305 STAINLESS

SKU#	SIZE	QTY	CT./MASTER	COLOR
0367158B	2-1/2" (64mm) x #10	350	4	Brown
0367159B		1750	1	
0367178B	3" (76mm) x #10	350	4	
037179B		1750	1	
0367158C	2-1/2" (64mm) x #10	350	4	Cedar
0367159C		1750	1	
0367178C	3" (76mm) x #10	350	4	
0367179C		1750	1	
0367158E	2-1/2" (64mm) x #10	350	4	Grey
0367159E		1750	1	
0367178E	3" (76mm) x #10	350	4	
0367179E		1750	1	
0367158T	2-1/2" (64mm) x #10	350	4	Tan
0367159T		1750	1	
0367178T	3" (76mm) x #10	350	4	
0367179T		1750	1	

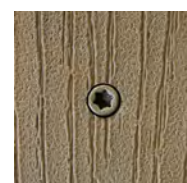
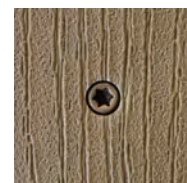

316 STAINLESS

SKU#	SIZE	QTY	CT./MASTER	COLOR
0367158BS	2-1/2" (64mm) x #10	350	4	Brown
0367159BS		1750	1	
0367178BS	3" (76mm) x #10	350	4	
0367179BS		1750	1	
0367158CS	2-1/2" (64mm) x #10	350	4	Cedar
0367159CS		1750	1	
0367178CS	3" (76mm) x #10	350	4	
0367179CS		1750	1	
0367158ES	2-1/2" (64mm) x #10	350	4	Grey
0367159ES		1750	1	
0367178ES	3" (76mm) x #10	350	4	
0367179ES		1750	1	

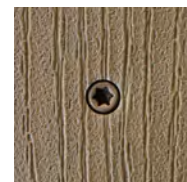

316 STAINLESS

SKU#	SIZE	QTY	CT./MASTER	COLOR
0367158DS	2-1/2" (64mm) x #10	350	4	Dark Brown
0367159DS		1750	1	
0367178DS	3" (76mm) x #10	350	4	
0367179DS		1750	1	
0367158MS	2-1/2" (64mm) x #10	350	4	Mocha
0367159MS		1750	1	
0367178MS	3" (76mm) x #10	350	4	
0367179MS		1750	1	
0367158NS	2-1/2" (64mm) x #10	350	4	Stone Grey
0367159NS		1750	1	
0367178NS	3" (76mm) x #10	350	4	
0367179NS		1750	1	
0367158RS	2-1/2" (64mm) x #10	350	4	Redwood
0367159RS		1750	1	
0367178RS	3" (76mm) x #10	350	4	
0367179RS		1750	1	
0367158SS	2-1/2" (64mm) x #10	350	4	Sand
0367159SS		1750	1	
0367178SS	3" (76mm) x #10	350	4	
0367179SS		1750	1	
0367158TS	2-1/2" (64mm) x #10	350	4	Tan
0367159TS		1750	1	
0367178TS	3" (76mm) x #10	350	4	
0367179TS		1750	1	
0367158WS	2-1/2" (64mm) x #10	350	4	Winchester
0367159WS		1750	1	
0367178WS	3" (76mm) x #10	350	4	
0367179WS		1750	1	

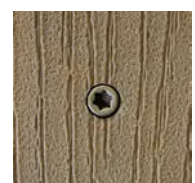

COLOR CROSS-REFERENCE GUIDE

MANUFACTURER			CAMO COLOR
PRODUCT	COLOR		
AZEK®	AZEK Deck - Arbor Collection	Acacia	Dark Brown
	AZEK Deck - Arbor Collection	Hazelwood	Ivory (NA)
	AZEK Deck - Arbor Collection	Silver Oak	Mocha
	AZEK Deck - Arbor Collection	Morado	Brown
	AZEK Deck - Arbor Collection	Mountain Redwood	Redwood
	AZEK Deck - Arbor Collection	Brazilian Walnut	Dark Brown
	AZEK Deck - Harvest Collection	Brownstone	Sand
	AZEK Deck - Harvest Collection	Slate Gray	Stone Grey
	AZEK Deck - Harvest Collection	Kona	Dark Brown
	AZEK Deck - Harvest Collection	Island Oak	Grey
	AZEK Deck - Harvest Collection	Autumn Chestnut	Winchester
	AZEK Deck - Vintage	Cypress	Cedar
	AZEK Deck - Vintage	Mahogany	Redwood
	AZEK Deck - Vintage	Dark Hickory	Grey
	AZEK Deck - Terra Collection	Sedona	Winchester
	AZEK Deck - Terra Collection	Tahoe	Grey
EverNew®	EverNew LT Decking	Dune	Sand
	EverNew LT Decking	Greystone	Stone Grey
	EverNew LT Decking	Jatoba	Brown
	EverNew LT Decking	Saddle	Tan
	EverNew LT Decking	Sequoia	Redwood
	EverNew LT Decking	Spanish Cedar	Brown
	EverNew PT Decking	Grey	Stone Grey
	EverNew PT Decking	Ipe	Brown
	EverNew PT Decking	Rosewood	Brown
	EverNew PT Decking	Castle Grey	Stone Grey
Fiberon®	Fiberon - Symmetry	Burnt Umber	Dark Brown
	Fiberon - Symmetry	Warm Sienna	Tan
	Fiberon - Symmetry	Cinnabar	Redwood
	Fiberon - Symmetry	Graphite	Grey
	Fiberon - Horizon	Ipe	Brown
	Fiberon - Horizon	Rosewood	Dark Brown
	Fiberon - Horizon	Tudor Brown	Brown
	Fiberon - Horizon	Castle Grey	Stone Grey
	Fiberon - Paramount	Brownstone	Brown
	Fiberon - Paramount	Earthstone	Dark Brown
	Fiberon - Paramount	Flagstone	Grey
	Fiberon - Paramount	Sandstone	Stone Grey
	Fiberon - Paramount	Mineral	Stone Grey
	Fiberon - Paramount	Fossil	Sand
	Fiberon - Sanctuary	Earl Grey	Grey
	Fiberon - Sanctuary	Latte	Winchester

FACE FASTENING

MANUFACTURER		COLOR	CAMO COLOR
PRODUCT			
Fiberon®	Fiberon - Sanctuary	Espresso	Dark Brown
	Fiberon - Protect	Western Cedar	Redwood
	Fiberon - Protect	Gray Birch	Grey
	Fiberon - Protect	Chestnut	Brown
	Fiberon - Relax	Barnwood Brown	Brown
	Fiberon - Relax	Front Porch Gray	Gray
Gossen®	Gossen - Heritage	Canyon Brown	Sand
	Gossen - Heritage	Seaside Sand	Stone Grey
	Gossen - Heritage	Cap Cod Grey	Stone Grey
	Gossen - American Classic	Desert Beige	Sand
	Gossen - American Classic	Harbor Grey	Stone Grey
	Gossen - Passport	London Grey	Grey
	Gossen - Passport	Moroccan Cedar	Cedar
	Gossen - Passport	Spanish Walnut	Brown
	Gossen - Passport	Tuscan Cherry	Redwood
	Gossen - Trailways	Acorn Brown	Sand
	Gossen - Trailways	Summit Grey	Grey
	Gossen - Trailways	Sierra Walnut	Tan
	Gossen - Trailways	Alpine Grey	Stone Grey
Latitudes®	Latitudes - Capricorn	Arabica	Dark Brown
	Latitudes - Capricorn	Koa	Redwood
	Latitudes - Intrepid	Cedar	Tan
	Latitudes - Intrepid	Gray	Grey
	Latitudes - Intrepid	Redwood	Redwood
	Latitudes - Intrepid	Walnut	Mocha
MoistureShield®	Moistureshield - Essential Collection™	Cape Cod Gray	Grey
	Moistureshield - Essential Collection™	Desert Sand	Tan
	Moistureshield - Essential Collection™	Seasoned Mahogany	Brown
	Moistureshield - Essential Collection™	TigerWood	Brown
	Moistureshield - Essential Collection™	Walnut	Brown
	Moistureshield - Vantage Collection™	Cape Cod Gray	Grey
	Moistureshield - Vantage Collection™	Desert Sand	Tan
	Moistureshield - Vantage Collection™	Seasoned Mahogany	Brown
	Moistureshield - Vantage Collection™	TigerWood	Brown
	Moistureshield - Vantage Collection™	Walnut	Brown
	Moistureshield - Vantage Collection™	Earthtone	Winchester
	Moistureshield - Vantage Collection™	Rustic Cedar	Cedar
	EverGrain - Classic	Cape Cod Grey	Grey

COMPOSITE COLOR CROSS-REFERENCE GUIDE

MANUFACTURER			CAMO COLOR	
PRODUCT	COLOR			
TAMKO®	EverGrain - Classic	Cedar	Cedar	
	EverGrain - Classic	Forest Green	N/A	
	EverGrain - Classic	Redwood	Redwood	
	EverGrain - Classic	Weathered Wood	Winchester	
	EverGrain - Envision	Shaded Auburn	Redwood	
	EverGrain - Envision	Spiced Teak	Brown	
	EverGrain - Envision	Rustic Walnut	Dark Brown	
	EverGrain - Envision	Greywood	Grey	
TimberTech®	TimberTech - Legacy Collection	Ashwood	Stone Grey	
	TimberTech - Legacy Collection	Mocha	NA	
	TimberTech - Legacy Collection	Pecan	Redwood	
	TimberTech - Legacy Collection	Tigerwood	Tan	
	TimberTech - Legacy Collection	Brown Oak	Brown	
	TimberTech - Legacy Collection	Rustic Elm	Dark Brown	
	TimberTech - Legacy Collection	Sandy Birch	Sand	
	TimberTech - Legacy Collection	Silver Maple	Grey	
	TimberTech - Tropical	Antigua Gold	Brown	
	TimberTech - Tropical	Antique Palm	Dark Brown	
	TimberTech - Tropical	Caribbean Redwood	Dark Brown	
	TimberTech - Tropical	Amazon Mist	Grey	
	TimberTech - Twin Finish	Redwood	Mocha	
	TimberTech - Twin Finish	Cedar	Mocha	
	TimberTech - Twin Finish	Grey	Stone Grey	
	TimberTech - Reliaboard	Cedar	Cedar	
	TREX®	Trex - Accents	Madiera	Brown
		Trex - Accents	Saddle	Brown
Trex - Accents		Winchester Grey	Winchester	
Trex - Accents		Woodland Brown	Dark Brown	
Trex - Transcend		Lava Rock	Dark Brown	
Trex - Transcend		Spiced Rum	Brown	
Trex - Transcend		Tiki Torch	Brown	
Trex - Transcend		Rope Swing	Sand	
Trex - Transcend		Fire Pit	Brown	
Trex - Transcend		Island Mist	Grey	
Trex - Transcend		Havana Gold	Tan	
Trex - Transcend		Gravel Path	Stone Grey	
Trex - Transcend		Tree House	Brown	
Trex - Transcend		Vintage Lantern	Dark Brown	
Trex - Enhance		Clam Shell	Grey	
Trex - Enhance		Beach Dune	Brown	

FACE FASTENING

MANUFACTURER			CAMO COLOR
PRODUCT	COLOR		
TREX®	Trex - Enhance	Saddle	Brown
	Trex - Select	Madeira	Redwood
	Trex - Select	Classic White	N/A
	Trex - Select	Saddle	Brown
	Trex - Select	Winchester Grey	Grey
	Trex - Select	Woodland Brown	Dark Brown
TUF Board®	TUF Board® - Alsek	Acorn	Mocha
	TUF Board® - Alsek	Sage	Winchester
	TUF Board® - Alsek	Sahara	Tan
	TUF Board® - Alsek	Gray	Grey
	TUF Board® - Bellus	Chestnut	Cedar
	TUF Board® - Bellus	Espresso	Dark Brown
	TUF Board® - Bellus	Terra Cotta	Redwood
	TUF Board® - Cierra	Slate	Grey
	TUF Board® - Cierra	Burnished Maple	Mocha
	TUF Board® - Cierra	Ebony	Dark Brown
	TUF Board® - Cierra	Red Cedar	Cedar
	TUF Board® - Cierra	Warm Walnut	Brown
	TUF Board® - Cierra	Sequoia	Redwood
	TUF Board® - Eco	Cherry - Cedar	Tan
	TUF Board® - Eco	Gray Oak - Cedar	Winchester
	TUF Board® - Eco	Alder	Mocha
	TUF Board® - Eco	Ash	Cedar
	TUF Board® - Eco	Pecan	Cedar
	TUF Board® - Eco	Driftwood - Cedar	Grey
	TUF Board® - Eco	Shady Oak - Cedar	Winchester
	TUF Board® - Kinbo	Black Walnut	Brown
	TUF Board® - Kinbo	Burnished Maple	Brown
	TUF Board® - Kinbo	Hickory	Brown
	TUF Board® - Kinbo	Red Cedar	Cedar
	TUF Board® - Kinbo	Tigerwood	Brown
	TUF Board® - Kinbo	Aged Ipe	Grey
	TUF Board® - Kinbo	Mahogany	Brown
	TUF Board® - Kinbo	Rosewood	Brown
	TUF Board® - Kinbo	Gray Walnut	Winchester
	TUF Board® - Kinbo	Antique Hickory	Mocha
TUF Board® - Kinbo	Walnut	Brown	

CAMO UNIVERSAL DECK CLIP



CAMO Clips are universal hidden fasteners that have incredible versatility to work with most grooved deck boards including Trex®, TimberTech®, AZEK®, Fiberon and many more, delivering a beautiful fastener-free deck top. The black oxide coating and stainless steel construction gives you excellent corrosion resistance. The CAMO Clips Limited Warranty gives you the security to relax and enjoy your deck.

WHAT MAKES THESE CLIPS PERFORM?

Pre-assembled - For fast, easy installation.

Spacing - 1/4" (6mm) automatic gap.

Star Drive - More points of contact to reduce cam-outs and deliver higher torque.

Serrated Clip Construction - Increased lateral holding power to prevent board creep.

Limited Warranty - CAMO® guarantees against rust and corrosion for the life of the project. We stand by our new and improved warranty. If the deck is installed following manufacturers' installation instructions and our fasteners damage the deck board, we'll replace the board. www.camofasteners.com/warranty

UNIVERSAL DECK CLIP

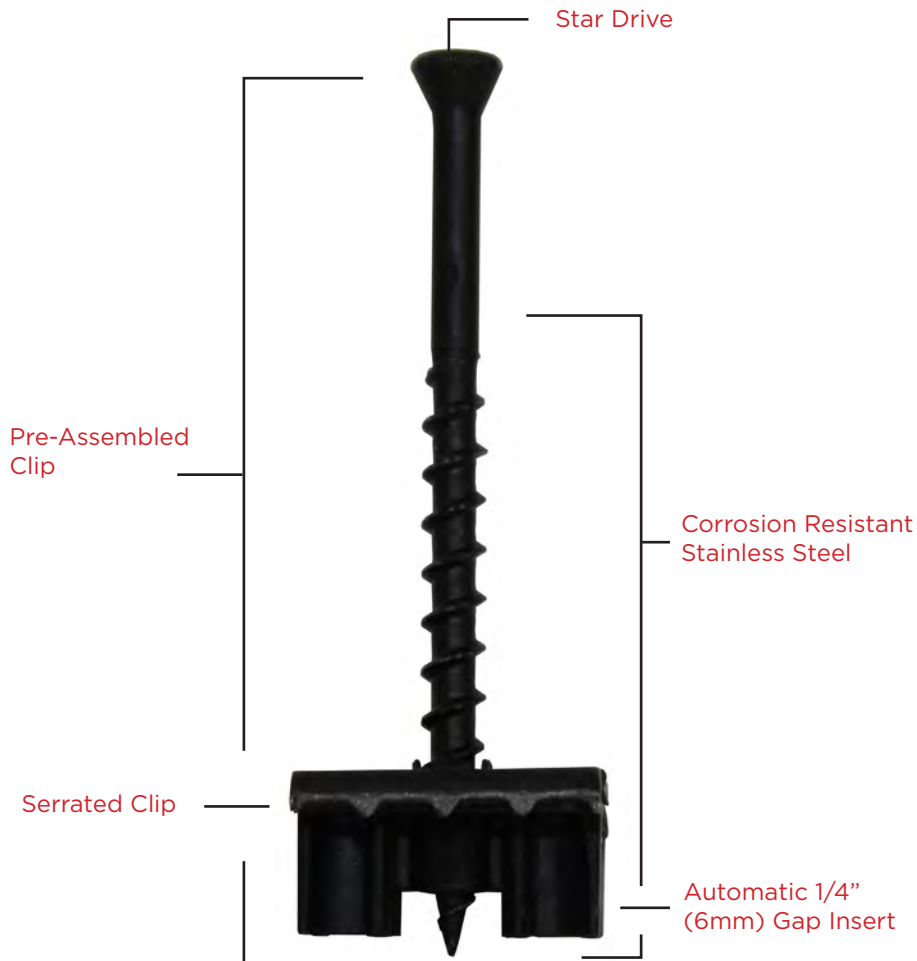

- Stainless Steel Clip and screw
- 1/4" (6mm) Automatic gap
- Fast and easy installation
- Beautiful, fastener-free surface
- Pre-assembled for easy installation
- 90-degree entry, easy board removal
- Serrated clip edge prevents board creep
- Star Drive
- Limited Warranty

SKU#	QTY	CT./MASTER
0343158	90	4
0343159	900	1



STRUCTURAL SCREWS



From deck substructure to landscape timbers, CAMO multi-purpose structural and ledger screws are an easy, code compliant way to replace 3/8" (10mm) and 1/2" (13mm) lag screws.

WHAT MAKES THESE STRUCTURAL SCREWS SECURE?

Independently Tested - Meet or exceed 2012 IRC requirements for 3/8" (10mm) and 1/2" (13mm) lag screws in specific applications.

Versatile - Wide variety of lengths for many structural applications.

Flat Head - Large surface area of the washer-style head provides stronger holding power.

ACQ Compatible - CAMO's proprietary ProTech coating provides three protective layers that pass a 1500 hour salt spray test in accordance with ASTM B117 and guards against corrosion when used with chemically treated wood.

Star Drive - More points of contact to reduce cam-outs and deliver higher torque.

Sharp Point - Enables fast starts and easy drive.

Limited Warranty - CAMO guarantees against rust and corrosion for the life of the project.

STRUCTURAL SCREWS

Multi-Purpose Screws

Ledger Screws*

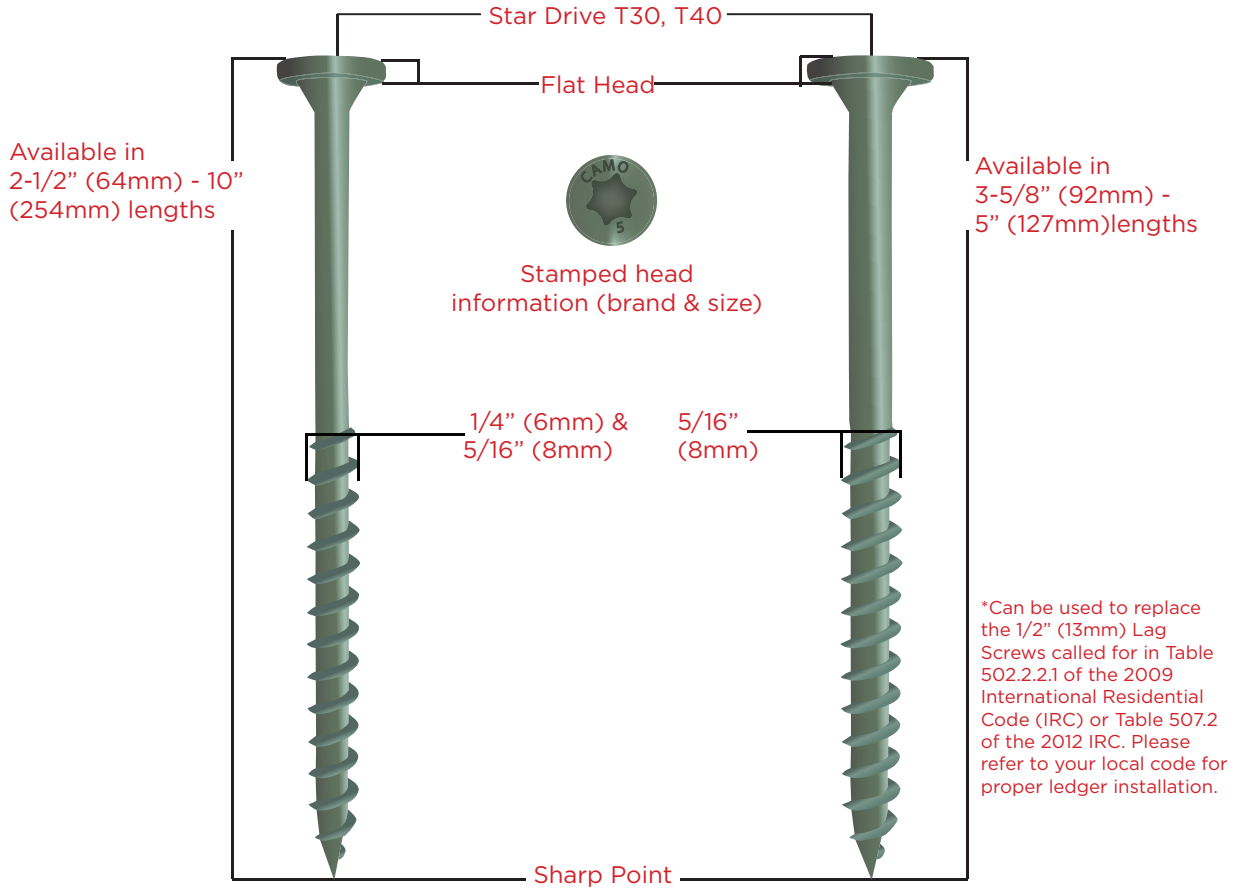

 CAMO Power Bit included in 50, 250 and 500ct. packages



STRUCTURAL SCREWS

ProTech COATED - MULTI-PURPOSE

SKU#	SIZE	QTY	CT./MASTER
0347150	2-1/2" (64mm) x 1/4" (6mm)	10	10
0347154		50	4
0347159		500	1
0347170	3" (76mm)x 1/4" (6mm)	10	10
0347174		50	4
0347179		500	1
0347190	3-1/2" (89mm) x 1/4" (6mm)	10	10
0347194		50	4
0347199		500	1
0347200	4" (102mm) x 1/4" (6mm)	10	10
0347204		50	4
0347209		250	1
0347220	5" (127 mm) x 1/4" (6mm)	10	10
0347224		50	4
0347229		250	1
0347240	6" (152mm) x 1/4" (6mm)	10	10
0347244		50	4
0347249		250	1
0347260	8" (203mm) x 1/4" (6mm)	10	10
0347269		250	1
0347270	10" (254mm) x 1/4" (6mm)	10	10
0347279		250	1

ProTech COATED - HEAVY DUTY

SKU#	SIZE	QTY	CT./MASTER
0347500	4" (102mm) x 5/16" (8mm)	10	10
0347504		50	4
0347509		250	1
0347540	6" (152mm) x 5/16" (8mm)	10	10
0347544		50	4
0347549		250	1
0347560	8" (203mm) x 5/16" (8mm)	10	10
0347569		250	1

ProTech COATED - LEDGER

SKU#	SIZE	QTY	CT./MASTER
0347490	3-5/8" (92mm) x 5/16" (8mm)	10	10
0347494		50	4
0347520	5" (127mm) x 5/16" (8mm)	10	10
0347524		50	4



STRUCTURAL SCREWS TEST DATA

Fastener Designation	Head Marking	Overall Length (in)	Length of Thread (in)	Unthreaded Shank Diameter (in)	Minor Thread Root Diameter	Outside Thread Diameter (in)
2-1/2"	CAMO 2.5	2.5	2	0.19	0.156	0.255
3"	CAMO 3	3	2	0.19	0.156	0.255
3-1/2"	CAMO 3.5	3.5	2	0.19	0.156	0.255
4"	CAMO 4	4	2	0.19	0.156	0.255
5"	CAMO 5	5	2	0.19	0.156	0.255
6"	CAMO 6	6	2	0.19	0.156	0.255
7"	CAMO 7	7	2	0.19	0.156	0.255
8"	CAMO 8	8	2	0.19	0.156	0.255
10"	CAMO 10	10	2	0.19	0.156	0.255

Fastener Designation	Head Marking	Overall Length (in)	Length of Thread (in)	Unthreaded Shank Diameter (in)	Minor Thread Root Diameter	Outside Thread Diameter (in)
3.625"	CAMO 3.625	3.625	2	0.212	0.193	0.305
5"	CAMO 5	5	3	0.212	0.193	0.305

ASTM F 606-11a, Standard Test Methods for Determining the Mechanical Properties of Externally and Internally Threaded Fasteners, Washers, Direct Tension Indicators, and Rivets (Single Shear)

ASTM 1575-03 (2008), Standard Test Method for Determining Bending Yield Moment of Nails (Bending Strength)

ASTM E 8/E8M-11, Standard Test Methods for Tension Testing of Metallic Materials (Tensile Strength)

Table 4A - CAMO Screws (Lateral Shear Values - Parallel to Grain) .55 specific gravity (SYP)

Fastener Designation	Fastener Type	Side Member Thickness (in)	Fastener Penetration (in)	Single Shear (two-member) Connection Parallel to Grain (lbs)	Reference Lateral Design Values
2-1/2"	Multi-Purpose	1.5	1	866	173
3"		1.5	1.5	1157	231
3-1/2"		1.5	2	1304	261
4"		1.5	2.5	1368	274
5"		1.5	3.5	2289	458
6"		1.5	4.5	2460	492
8"		1.5	6.5	2477	495
10"		1.5	8.5	1803	361
3.625"	Ledger	1.5	2.125	1814	363
5"		1.5	3.5	2048	410

ASTM D 1761-06, Standard Test Methods for Mechanical Fasteners in Wood (Lateral Shear)

Table 4B - CAMO Screws (Lateral Shear Values - Perpendicular to Grain) .55 specific gravity (SYP)

Fastener Designation	Fastener Type	Side Member Thickness (in)	Fastener Penetration (in)	Single Shear (two-member) Connection Parallel to Grain (lbs)	Reference Lateral Design Values
2-1/2"	Multi-Purpose	1.5	1	1105	221
3"		1.5	1.5	1765	353
3-1/2"		1.5	2	1724	345
4"		1.5	2.5	2002	400
5"		1.5	3.5	2449	490
6"		1.5	4.5	2335	467
8"		1.5	6.5	2792	558
10"		1.5	8.5	2233	447
3.625"	Ledger	1.5	2.125	2068	414
5"		1.5	3.5	2250	450

ASTM D 1761-06, Standard Test Methods for Mechanical Fasteners in Wood (Lateral Shear)

Table 4C - CAMO Screws (Rafter/Truss to Top Plate Uplift) .55 specific gravity (SYP)

Fastener Designation	Fastener Type	Side Member Thickness (in)	Fastener Penetration (in)	Single Shear (two-member) Connection Parallel to Grain (lbs)
2-1/2"	Multi-Purpose	2	0.5	841
3"		2	1	1406
3-1/2"		2	1.5	1986
4"		2	2	2129
5"		2	3	2518
6"		2	4	2137
8"		2	6	2002
10"		2	8	2250

Allowable Strength					
Bending Yield Strength (psi) [lbs]	Tensile Strength (psi) [lb]	Single Shear Strength (psi) [lb]	Bending Yield [lb] (psi)	Tensile [lb] (psi)	Shear [lb] (psi)
[418] 153,600	[4565] 152,900	[2715] 141,600	153,600	[1520] 50,916	[904] 141,600

Allowable Steel Strength					
Bending Yield Strength (psi) [lbs]	Tensile Strength (psi) [lb]	Single Shear Strength (psi) [lb]	Bending Yield [lb] (psi)	Tensile [lb] (psi)	Shear [lb] (psi)
[485] 134,600	[5438] 182,100	[3233] 117,100	134,600	[1810] 50,729	[1077] 38,994

Table 2 - CAMO Screws (Direct Withdrawal Values) .55 specific gravity (SYP)

Fastener Designation	Fastener Type	Length of Thread	Withdrawal Strength (lbs/in)		Design Values (Reduced by safety factor)	
			Dry	Wet	Dry	Wet
2-1/2"	Multi-Purpose	2	1003	700	201	140
3"		2	1058	725	212	145
3-1/2"		2	994	809	119	162
4"		2	986	918	197	184
5"		2	1299	945	260	189
6"		2	1279	1218	256	244
8"		2	1389	1389	278	278
10"		2	1195	999	239	200
3.625"	Ledger	2	1232	940	246	188
5"		2	1886	1448	377	290

ASTM D 1761-06, Standard Test Methods for Mechanical Fasteners in Wood (Lateral Shear)

Table 3 - CAMO Screws (Pull Through Values) .55 specific gravity (SYP)

Fastener Designation	Fastener Type	Length of Thread	Pull-Through (lbs/in)
2-1/2"	Multi-Purpose	2	1185
3"		2	1245
3-1/2"		2	1201
4"		2	1219
5"		2	1511
6"		2	1316
8"		2	1286
10"		2	1331
3.625"	Ledger	2	1322
5"		2	1176

ASTM D 1761-06, Standard Test Methods for Mechanical Fasteners in Wood (Lateral Shear)

NATIONAL NAIL

Your brand experience should be special. At National Nail, our brands should make you a *rock star* when it comes to providing product solutions your customers need. The products position you as an innovation leader with new technologies that make builders better at what they do.

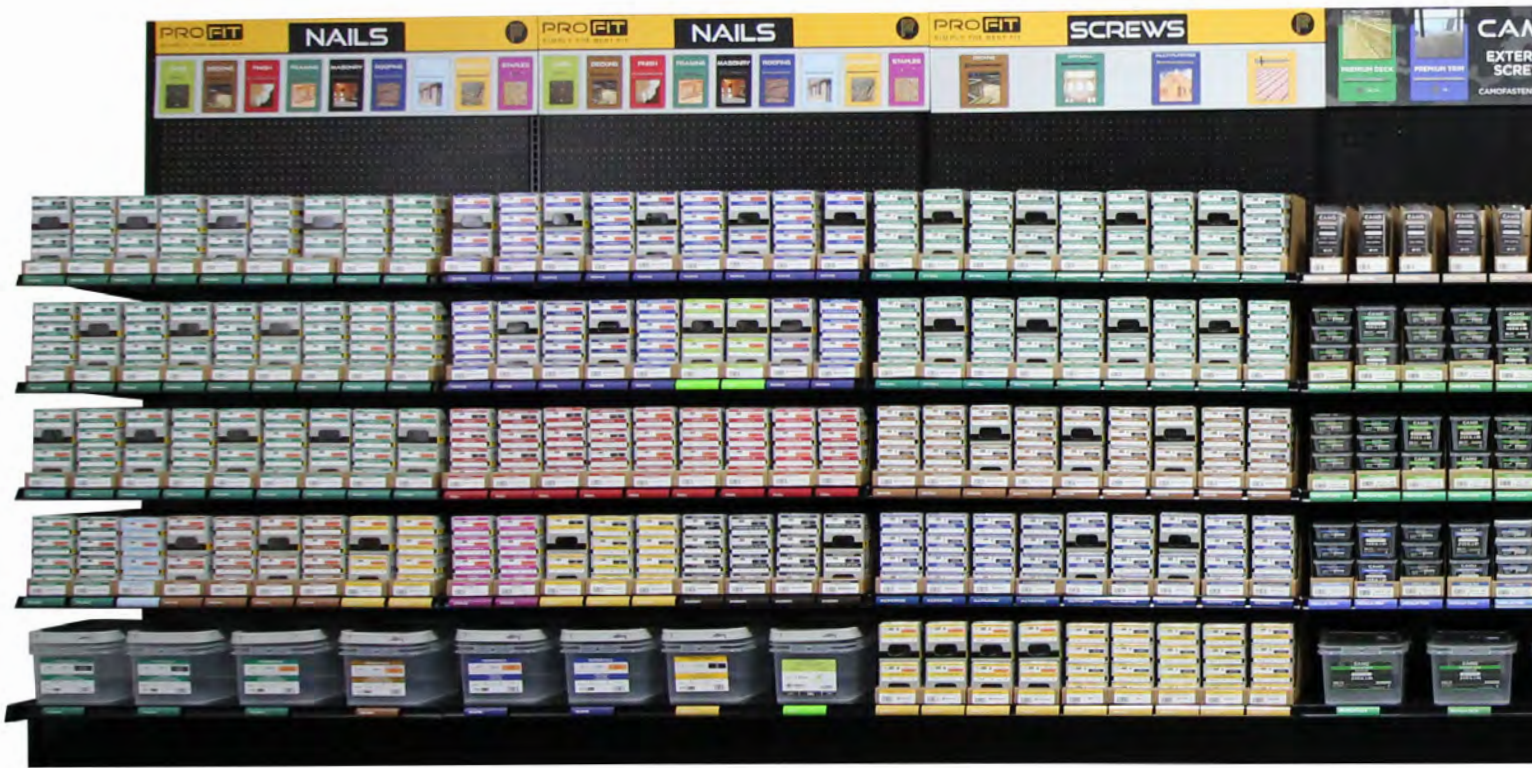

PROFIT

Packaged and Bulk Nails

- Framing
- Finish
- Roofing
- Specialty
- Masonry
- Staples
- Decking
- Siding
- Caps

Packaged and Bulk Screws

- Decking
- Drywall
- Multi-Purpose
- Specialty

Collated Fasteners

- Framing
- Roofing
- Finish
- Staples
- Siding
- Metal Connector
- ProjectPac

OUR BRANDS

Our goal is to make you the destination for “asked for” brands and products, and we’ll provide you with **Dress for Success** merchandising that brings your customer from the parking lot to the aisle and makes product selection easy.

We want your business to be relevant, profitable, and growing because our brands are part of your story. And that makes your customers’ brand experience special too!



CAMO®

Edge Deck Fastening System +

- Marksman Edge
- Marksman Pro Guides
- Edge Deck Screws
- Driver and Pre-Drill Bits

+ Also available for contractors - The Edge Pro™ high-speed, collated edge deck fastening system.

Exterior Screws

- Premium Deck Screws
- Composite Screws
- Structural Screws
- Premium Trim Screws
- Universal Deck Clips

STINGER®

Roofing/Sidewall Solutions

- Cap Hammers
- Cap Staplers
- Cap Nailers
- Cap Fasteners (Staples, Collated Nails and Hand Drive Nails)
- Coil Roofing Nails
- Hand Drive Roofing Nails
- Hammer Tackers
- Synthetic Underlayment

CAMO®

WWW.CAMOFASTENERS.COM

MICHIGAN

2964 Clydon Ave SW
Grand Rapids, MI 49519
800-968-6245

NEW YORK

5985 Tarbell Rd
Syracuse, NY 13206
800-521-1115

GEORGIA

555 Riverside Pkwy, Ste. 100
Austell, GA 30168
877-312-2388

TEXAS

1312 West Crosby Rd
Carrollton, TX 75006
877-312-2388

CALIFORNIA

8939 Etiwanda Ave
Rancho Cucamonga, CA 91739
800-968-6245



WWW.NATIONALNAIL.COM